

SKP90

Steel Sheet Pile Connector

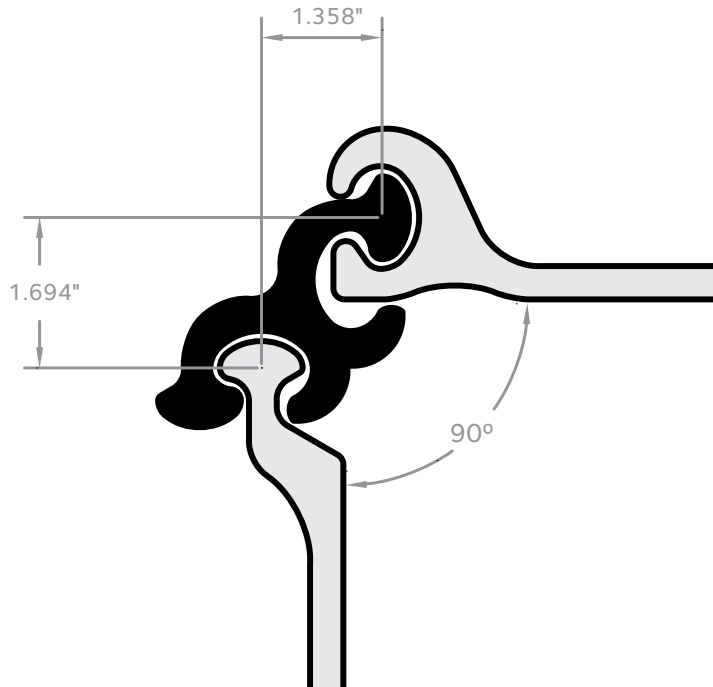

ASTM A572 Gr. 60
9.08 lb/ft

- Designed for use with Ball & Socket (PZ/PZC) Applications
- Can Be Used in 16 Different Orientations

ATTACHMENT PROCEDURE

1. Thread connector into interlock of sheet pile.
2. Tack weld connector to pile.

Orientations

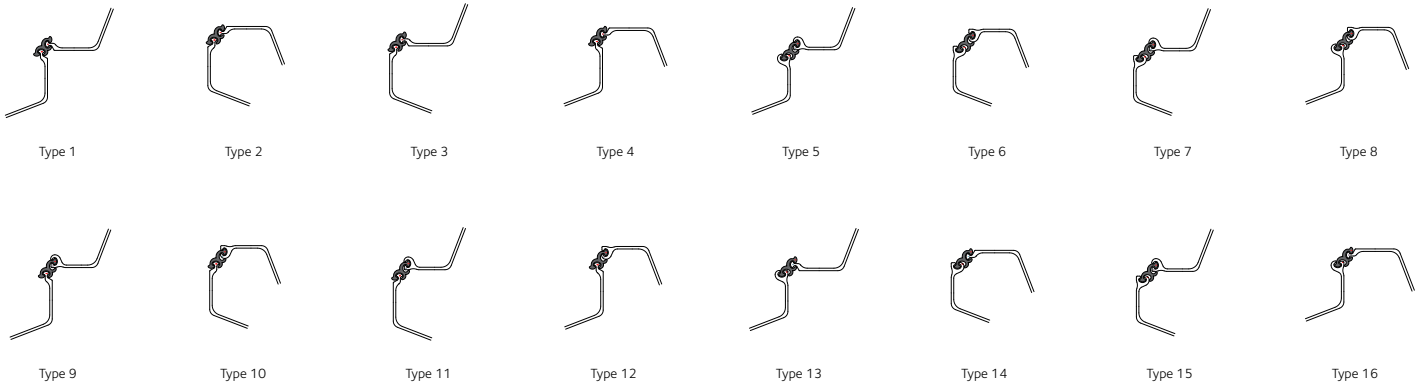

	<p>ASSOCIATED PILE & FITTING</p>	<p>45 Samworth Road, Clifton, NJ 07014 Tel: 973-773-8400 Fax: 973-773-8442 email: apf@associatedpile.com www.associatedpile.com Call Toll Free: 800-526-9047</p>
--	---	---

SKP45

Steel Sheet Pile Connector

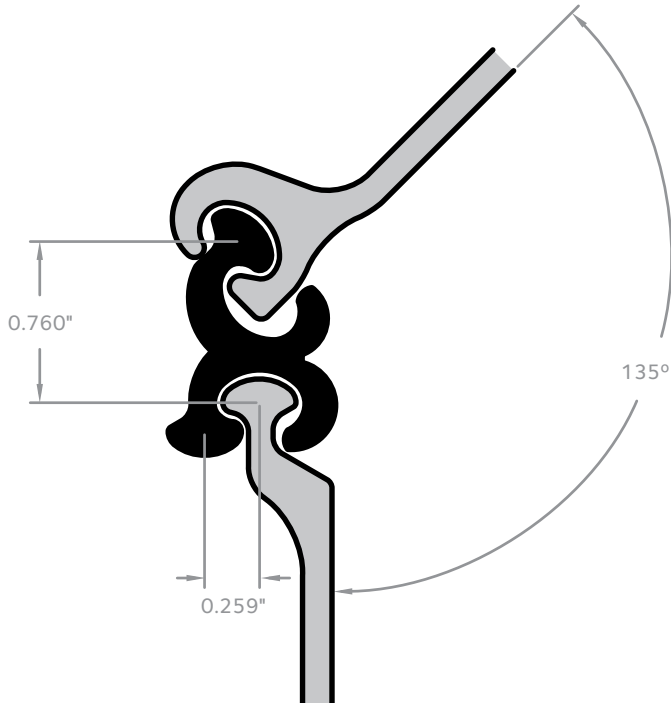

ASTM A572 Gr. 60
8.97 lb/ft

- Designed for use in Ball & Socket (PZ/PZC) Applications
- Can Be Used in 16 Different Orientations

ATTACHMENT PROCEDURE

1. Thread connector into interlock of sheet pile.
2. Tack weld connector to pile.

Orientations

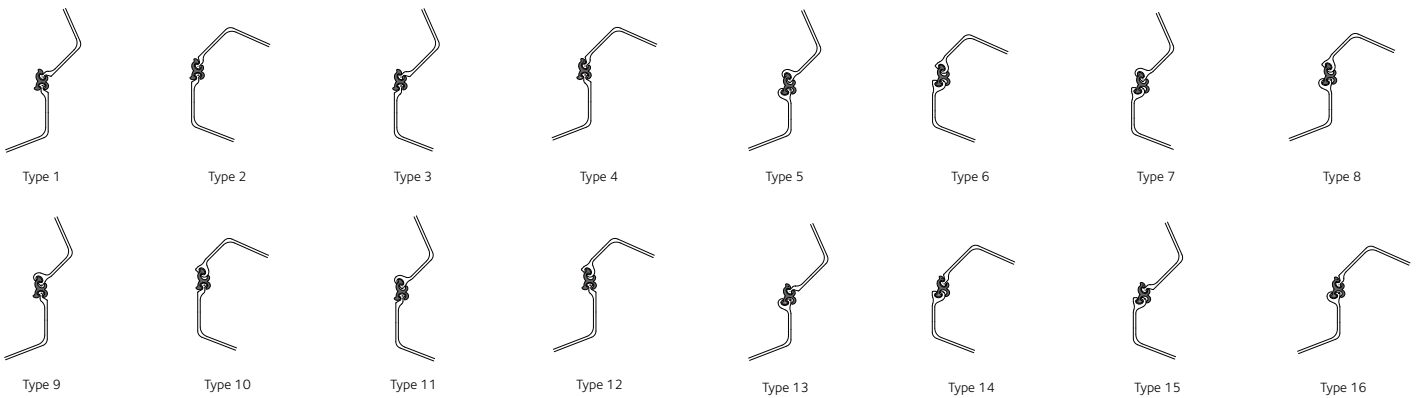

**ASSOCIATED PILE
& FITTING**

45 Samworth Road, Clifton, NJ 07014
 Tel: 973-773-8400
 Fax: 973-773-8442
 email: apf@associatedpile.com
www.associatedpile.com
 Call Toll Free: 800-526-9047

SKPT

Steel Sheet Pile Connector

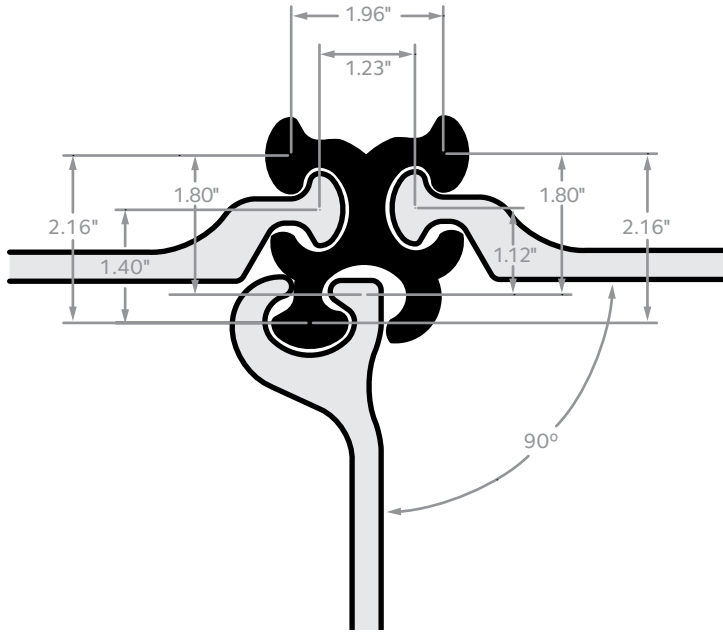

ASTM A572 Gr. 60
11.30 lb/ft

- Designed for use in Ball & Socket (PZ/PZC) Applications
- Can Be Used in 64 Different Orientations

ATTACHMENT PROCEDURE

1. Thread connector into interlock of sheet pile.
2. Tack weld connector to pile.

Orientations

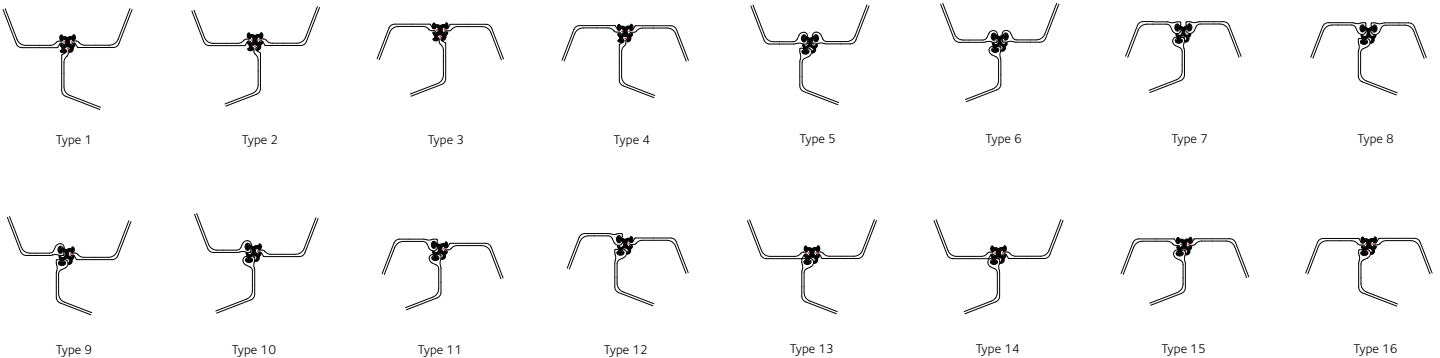

**ASSOCIATED PILE
& FITTING**

45 Samworth Road, Clifton, NJ 07014
 Tel: 973-773-8400
 Fax: 973-773-8442
 email: apf@associatedpile.com
www.associatedpile.com
 Call Toll Free: 800-526-9047

SKPT

Steel Sheet Pile Connector

Orientations

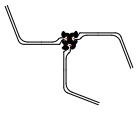

Type 17

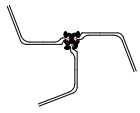

Type 18

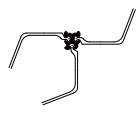

Type 19

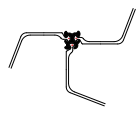

Type 20

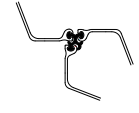

Type 21

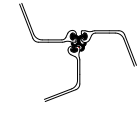

Type 22

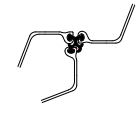

Type 23

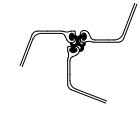

Type 24

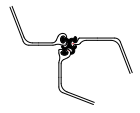

Type 25

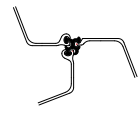

Type 26

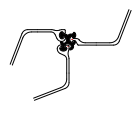

Type 27

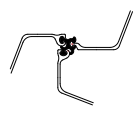

Type 28

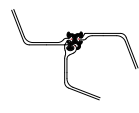

Type 29

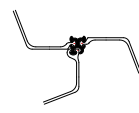

Type 30

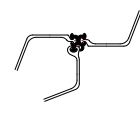

Type 31

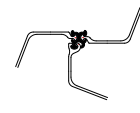

Type 32

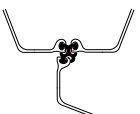

Type 33

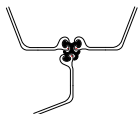

Type 34

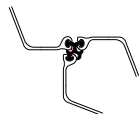

Type 35



Type 36

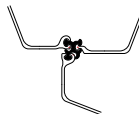

Type 49

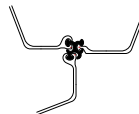

Type 50



Type 51

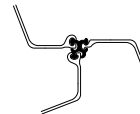

Type 52



Type 37



Type 38

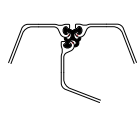

Type 39



Type 40

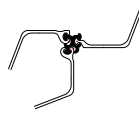

Type 53

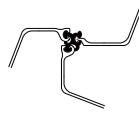

Type 54

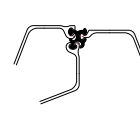

Type 55

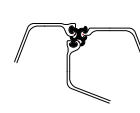

Type 56

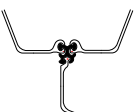

Type 41

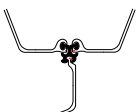

Type 42



Type 43

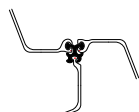

Type 44

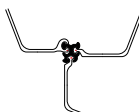

Type 57

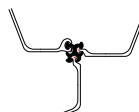

Type 58

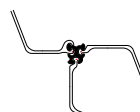

Type 59

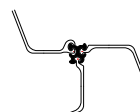

Type 60

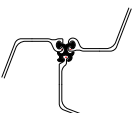

Type 45



Type 46

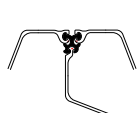

Type 47

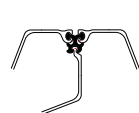

Type 48

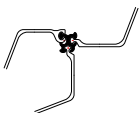

Type 61

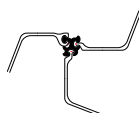

Type 62

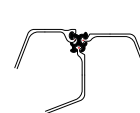

Type 63

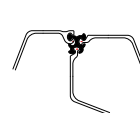

Type 64



**ASSOCIATED PILE
& FITTING**

45 Samworth Road, Clifton, NJ 07014
Tel: 973-773-8400
Fax: 973-773-8442
email: apf@associatedpile.com
www.associatedpile.com
Call Toll Free: 800-526-9047

SKPF

Steel Sheet Pile Connector

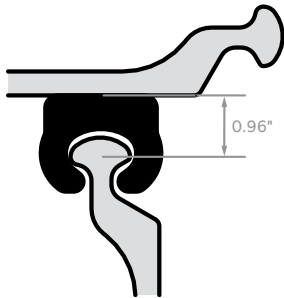

PZ/PZC

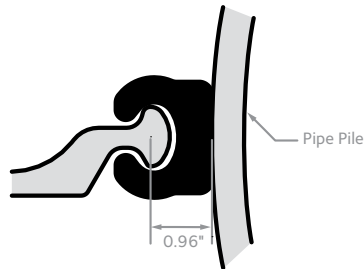

Pipe

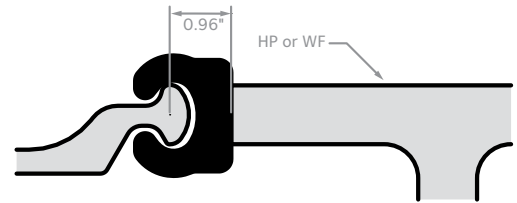

H-pile

ASTM A572 Gr. 60
6.13 lb/ft

- Combination Connectors: Designed for use with Pipe, H-pile & PZ/PZC Sheet Pile
- Weld-on Connectors

ATTACHMENT PROCEDURE

1. Thread connector into interlock of sheet pile.
2. Tack weld connector to pile.



**ASSOCIATED PILE
& FITTING**

45 Samworth Road, Clifton, NJ 07014
Tel: 973-773-8400
Fax: 973-773-8442
email: apf@associatedpile.com
www.associatedpile.com
Call Toll Free: 800-526-9047

SKPM

Steel Sheet Pile Connector

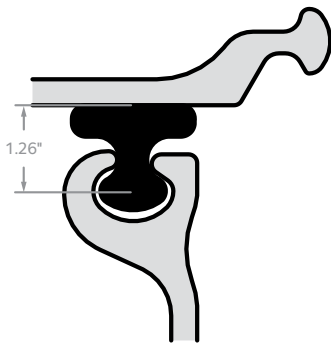

PZ/PZC

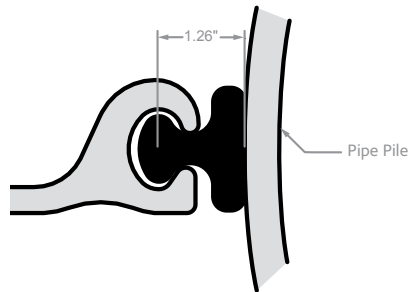

Pipe

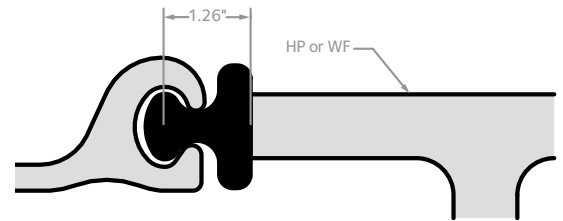

H-pile

ASTM A572 Gr. 60
4.95 lb/ft

- Combination Connectors: Designed for use with Pipe, H-pile & PZ/PZC Sheet Pile
- Weld-on Connectors

ATTACHMENT PROCEDURE

1. Thread connector into interlock of sheet pile.
2. Tack weld connector to pile.



**ASSOCIATED PILE
& FITTING**

45 Samworth Road, Clifton, NJ 07014
Tel: 973-773-8400
Fax: 973-773-8442
email: apf@associatedpile.com
www.associatedpile.com
Call Toll Free: 800-526-9047